

JAMES LEE.

Improvement in Breech-Loading Fire-Arms.

No. 116,068.

Patented June 20, 1871.

Fig. 1.

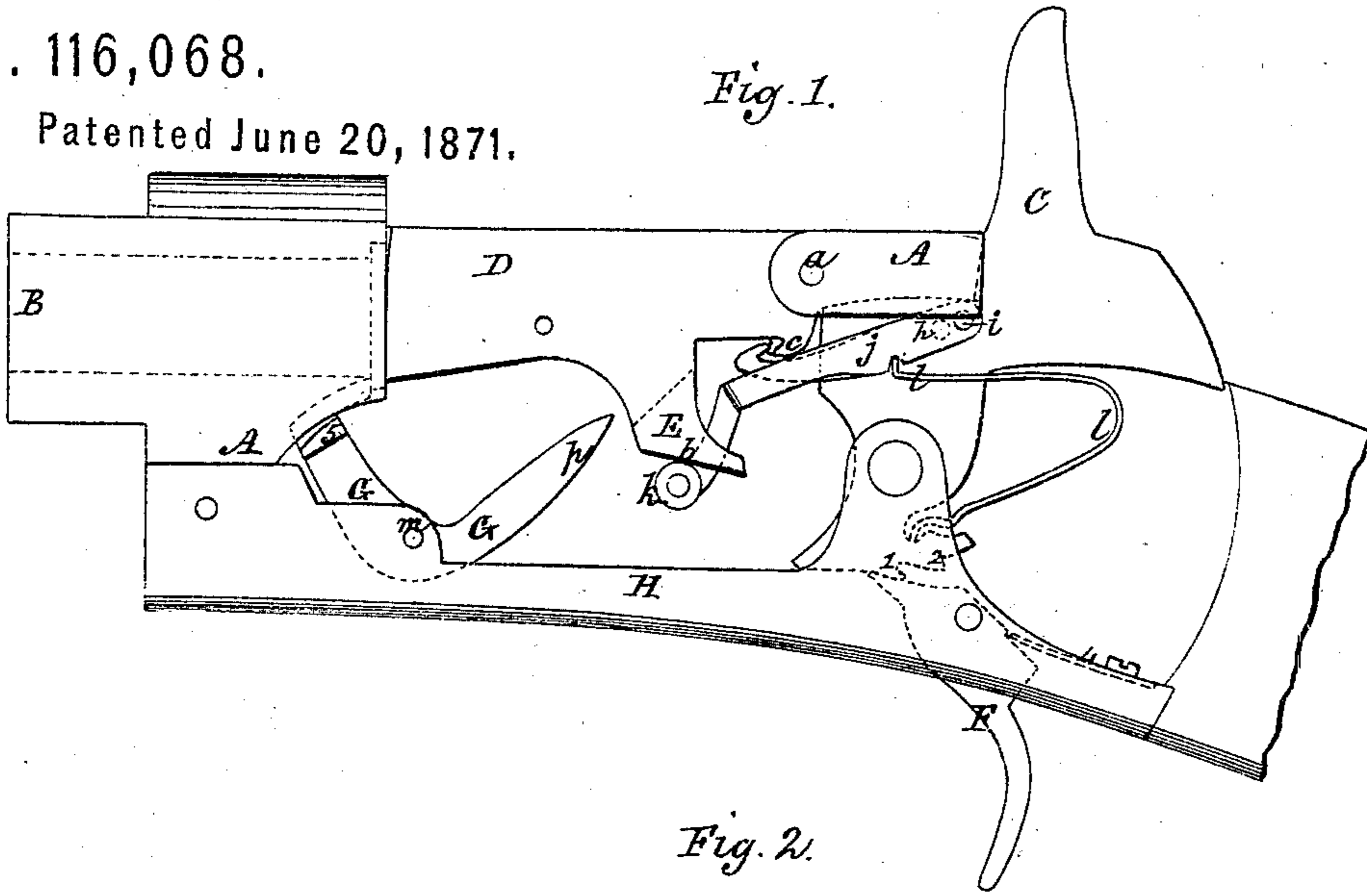

Fig. 2.

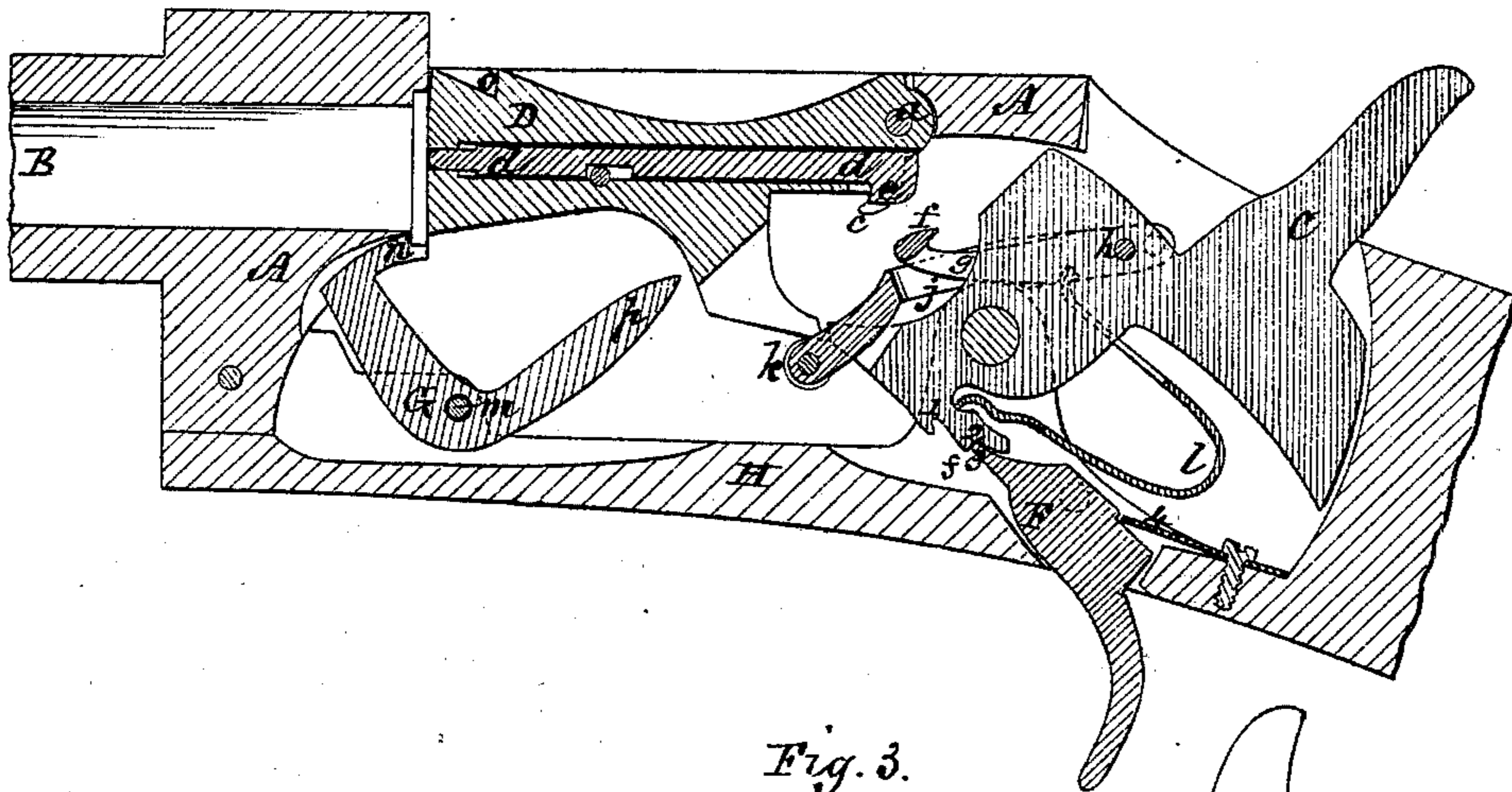
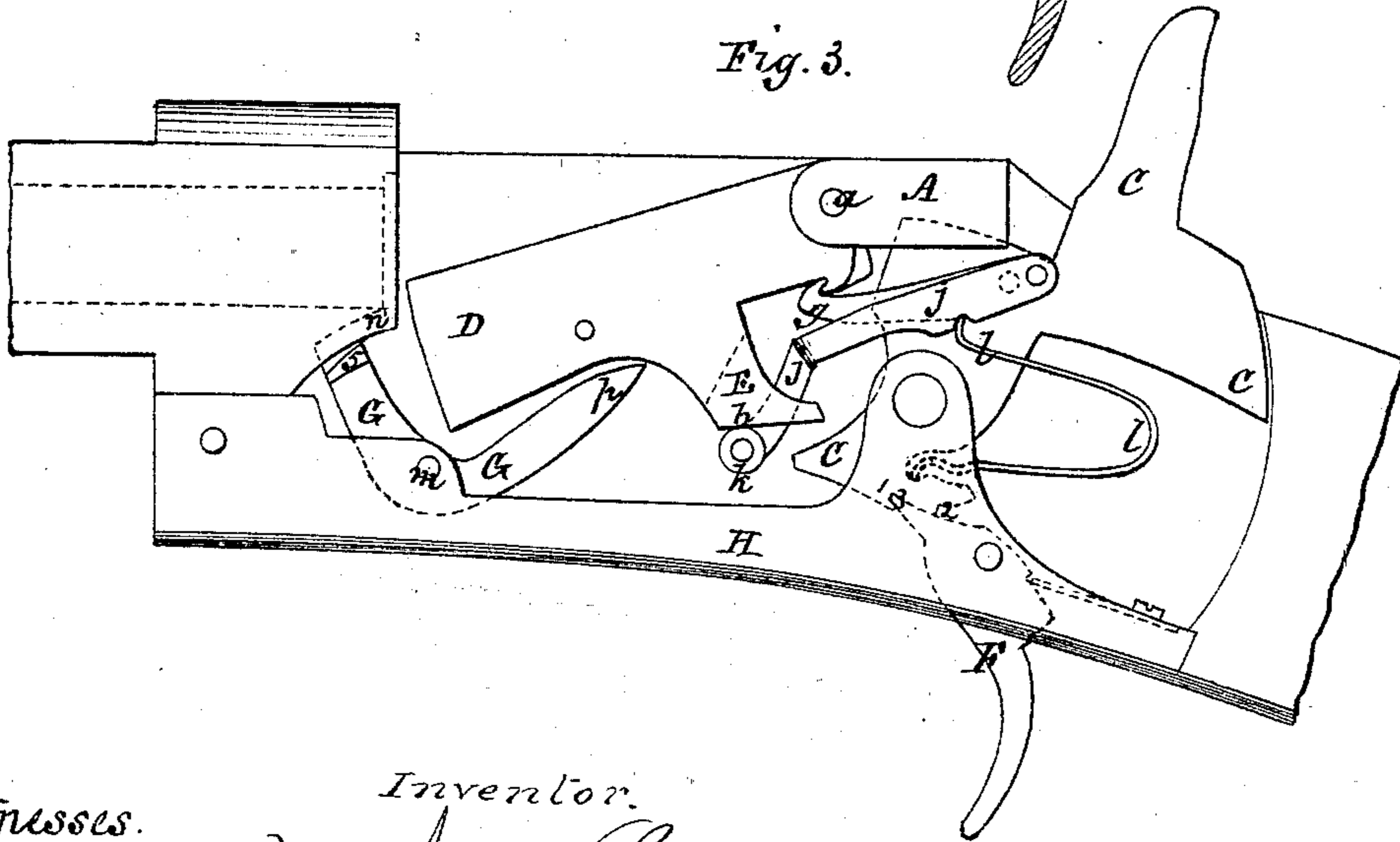

Fig. 3.



Witnesses.
 E. E. Wilson }
 Edmund Masson }
 Inventor.
 James Lee.
 By atty. A. B. Stoughton.

JAMES LEE.

Improvement in Breech-Loading Fire-Arms.

No. 116,068.

Patented June 20, 1871.

Fig. 4.

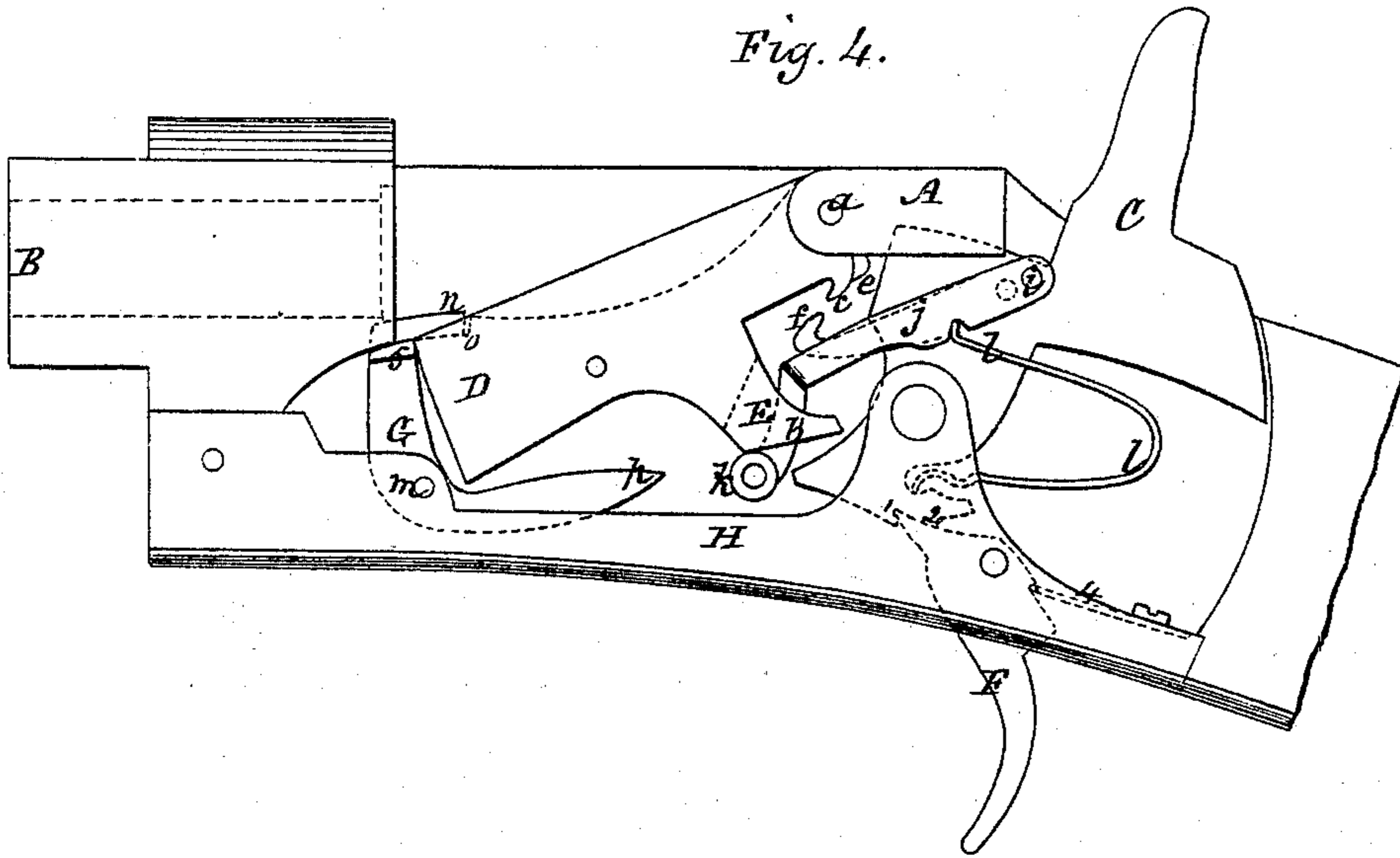

Fig. 5.

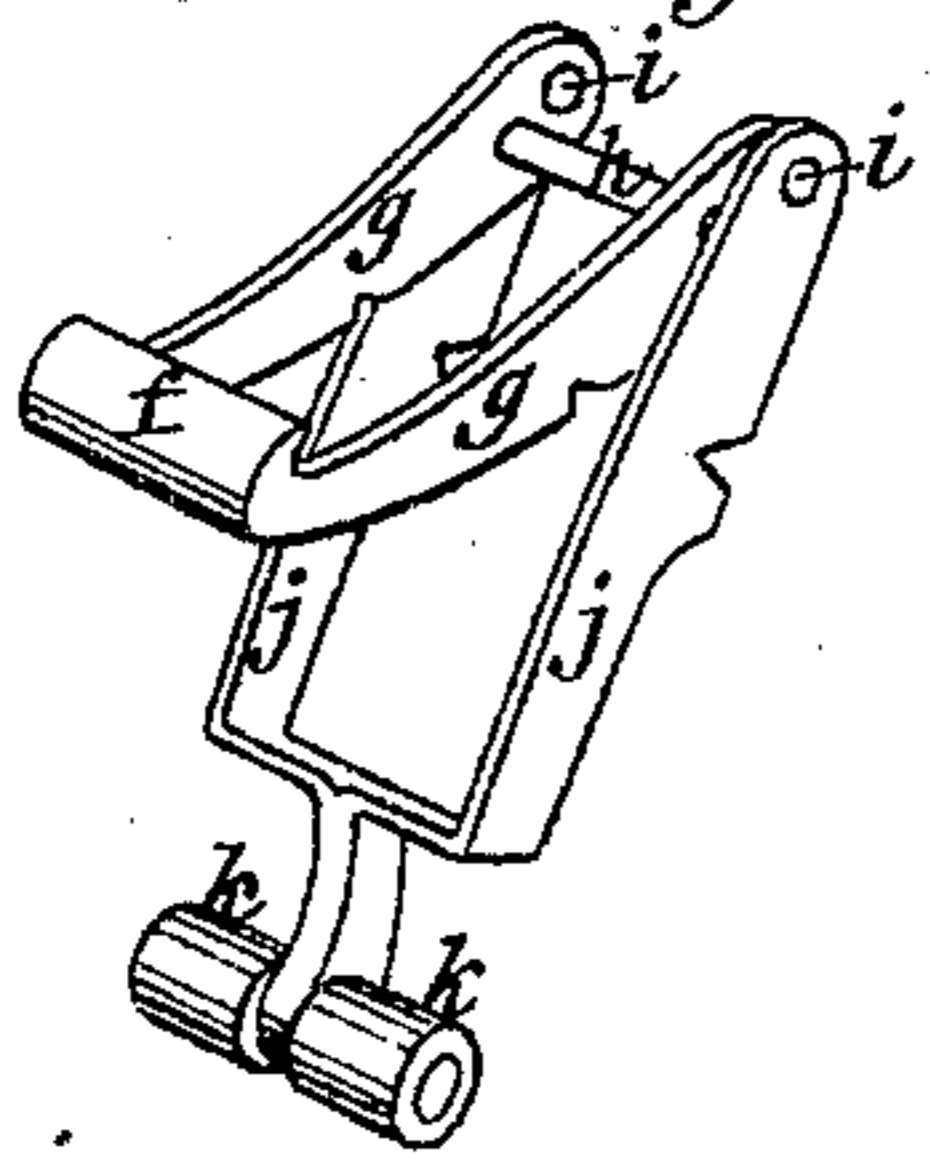

Fig. 6.

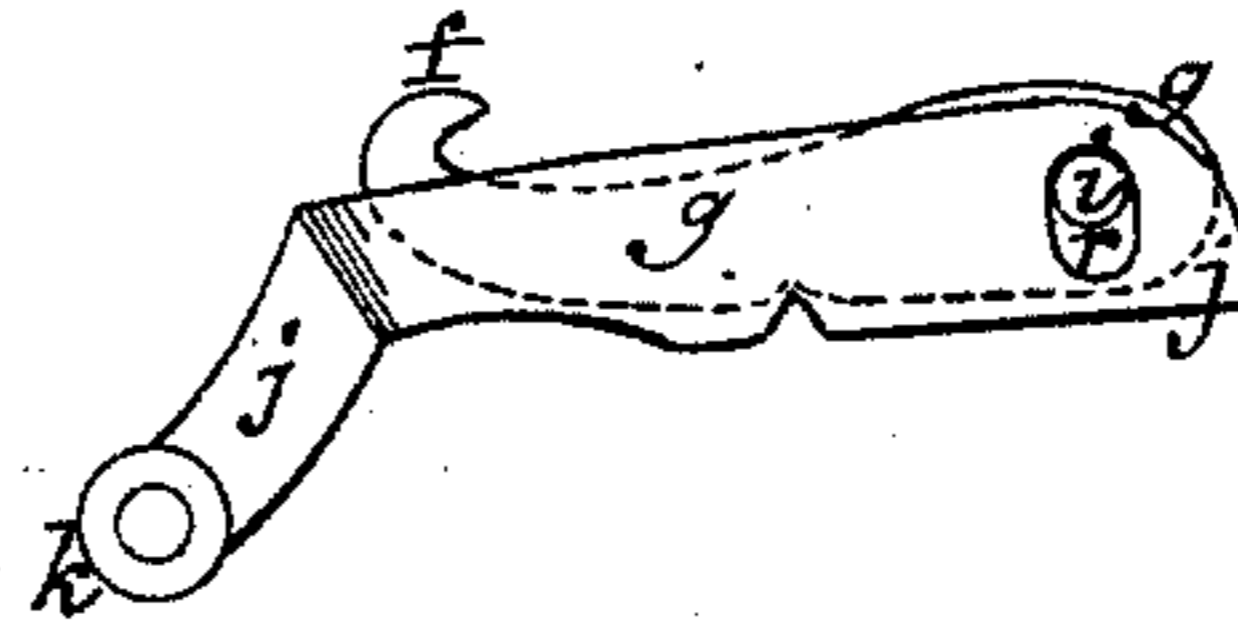
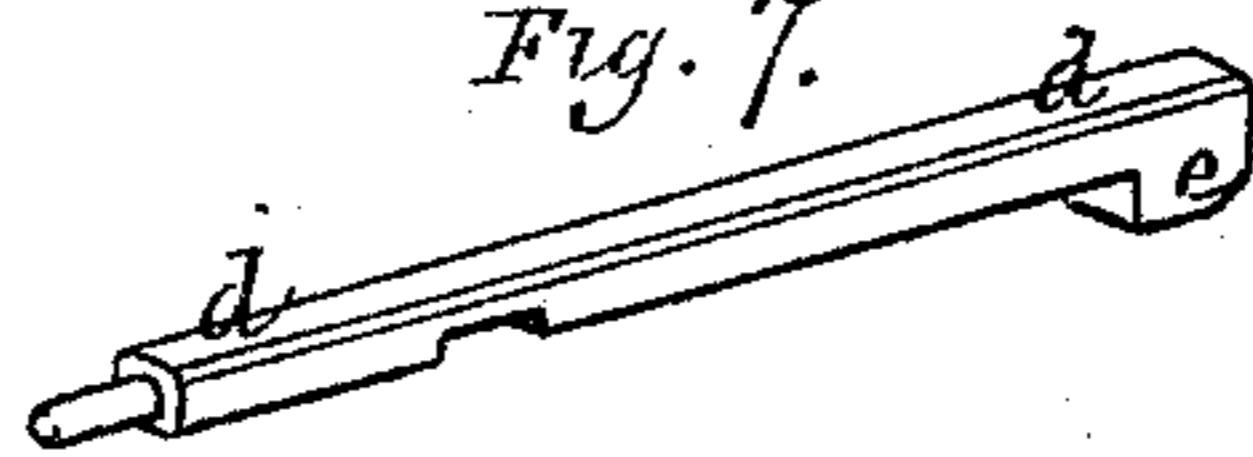

Fig. 7.



Witnesses. }
C. Wilson }
Edmund Masson }
 Inventor. }
James Lee. }
 By atty. *A. B. Stoughton.*

UNITED STATES PATENT OFFICE.

JAMES LEE, OF MILWAUKEE, WISCONSIN, ASSIGNOR TO PHILO REMINGTON,
OF ILION, NEW YORK.

IMPROVEMENT IN BREECH-LOADING FIRE-ARMS.

Specification forming part of Letters Patent No. 116,068, dated June 20, 1871.

To all whom it may concern:

Be it known that I, JAMES LEE, of Milwaukee, in the county of Milwaukee and State of Wisconsin, have invented certain new and useful Improvements in Breech-Loading Fire-Arms; and I do hereby declare the following to be a full, clear, and exact description of the same, reference being had to the accompanying drawing making a part of this specification, in which—

Figure 1 represents a side view of so much of a fire-arm as will illustrate my invention, and in which the co-operative or moving parts are shown in the positions they assume when the arm has been fired. Fig. 2 represents a longitudinal vertical section taken through the arm, showing the hammer at full-cock, and the other moving parts in the positions they assume when the arm is ready to be discharged. Fig. 3 represents a side view, showing the hammer at half-cock, the breech-block down, the hooks still engaged, and the extractor in its inactive position. Fig. 4 represents a side view, showing the positions of the several parts when the hammer is drawn down to the half-cock notch, and then allowed to drop into said notch, which movement throws up the extractor and allows it to catch upon the front or free end of the breech-block to hold it down, and allows the hammer-spring to disengage the hooks. Fig. 5 represents, in perspective and detached from the arm, the hook and mainspring-levers that work in connection with the hammer and breech-block. Fig. 6 represents a modification of the hook and mainspring-levers that work in connection with the hammer and breech-block, in which there is but one pivot-connection instead of two. Fig. 7 represents a view of the firing-pin detached from the arm.

Similar letters of reference, where they occur in the several separate figures, denote like parts of the fire-arm in the drawing.

My invention consists, first, in the combination of a hammer with a hook attached, and a breech-block hinged at its rear end, and so arranged that on pulling back said hammer to half-cock the hook shall first draw back the firing-pin and then draw down the breech-block to a loading position, and on the breech being retained in such position by the ejector,

said hook shall disconnect itself from the breech-block and allow the latter to be moved up into a closed position by the action of the mainspring through the mainspring-lever, and the hammer to be brought to a full-cock. It further consists in a mainspring that is attached to and moves with the hammer, and has no fixed position in whole or in part, and yet performs all the duties of an expansile and contractile spring. It further consists in the operation of a mainspring and lever that is caused to raise the breech-block and to attach and detach a hook; and of an ejector that will hold the breech in a loading position, and that also closes the space between the end of the frame and the end of the breech-block, and has play enough on its pivot to allow the force of the mainspring to hold it to the under part of the frame and to the top of the breech-block. It further consists in the combination of a breech-block hinged at its rear end with a hammer-lever and mainspring, for the purpose of closing said breech and of operating said hammer. It further consists in the combination of a lever, hook, and mainspring, for the purpose of connecting and disconnecting said hook to and from the breech-block. It further consists in the combination of a breech-block, hinged at its rear end, and an ejector of such form that it will hook over and hold the breech-block when said breech-block has been brought to a loading position. It further consists in a mechanism for drawing back the firing-pin, which is actuated through the hammer as the hammer is drawn back to depress the breech-block.

To enable others skilled in the art to make and use my invention, I will proceed to describe the same with reference to the drawing.

The frame of the gun is represented at A. B is the barrel; C, the hammer; and D, a breech-block, hinged to the frame at *a*. On the under part of the breech-block there is a projection, E, having a plane, *b*, at its under side, for the lever which raises it to close to the bore of the arm to move upon, as will be explained. On the rear under side of the breech-block there is a lip or hook, *c*, with which a hook on a lever connected with the hammer engages to draw down the breech-block into a loading position. The firing-pin

d, better seen in Fig. 7, which passes centrally through the breech-block in a round opening made therethrough, has a portion of its circumference cut away to prevent it from sticking or clogging by any dirt that may accumulate therein; it further has, at its rear end, a hook or lip, *e*, corresponding with and in the same plane as the hook or lip *c* on the breech-block, and so that the hoop *f* may engage with both of the hooks *c* and *e*, and at the first of the movement of the hammer draw back the firing-pin, and then, by continuing its movement, draw down the breech-block to the loading position. The hook *f* is pivoted to the hammer at *h*, and its rear ends project back of or beyond said pivoted point, and to these extreme rear ends, as at *i*, the arms *j* of the lifting-lever are pivoted, said lever having at its forward or free ends friction-rolls *k*, which bear against and run upon the surface *b* on the projection E, and are held there by the expansion of the mainspring *l*, the upper end of which always bears against the arms *j*, and intermittently (as will be explained) against the arms *g*. The mainspring *l* is attached to and moves with the hammer, and is not united to any immovable part of the frame or arm.

The advantage of this arrangement of mainspring so hung is that, being supported at the two ends on and moving with the hammer, and having no sliding bearings, there is no power lost in friction. It avoids the use of a swivel or other intermediate or extra piece to fasten to or with, as now used. It avoids the necessity of extending the guard-strap back to afford a point of attachment.

The half and full-cock notches are made in the under part of the hammer, as at 1 2, and the point 3 of the trigger F, which is controlled by a spring, 4, takes into these notches and holds the hammer in the positions they respectively indicate. The ejector G is pivoted to the guard-strap H, on which the lock is also assembled, so as to be easily taken out, and said ejector is allowed to work freely or loosely on its pivot *m*, so that it may have some motion independent of its pivot, so as to bind it against the frame A and upon the top of the breech-block, by the reactive force of the mainspring, through said breech-block. The top of the ejector has upon it a nib, *n*, which takes into a recess, *o*, in the top of the breech-block. It also has upon it lateral projections 5, which, when the ejector is holding down the breech-block in the loading position, close up the space or bridge the space between the frame and the breech-block. The tail *p* of the ejector extends underneath, so as to be struck by the breech-block when it is drawn down, and thus the ejector throws out the empty case and at the same time holds the breech-block down in the loading position. In Fig. 6 I have shown a modified construction of the hook and lifting-levers, both of which are pivoted at *i*; but by reason of the slots in the arms *j*, as at *r*, the levers may have their independent movements and actions the same that they would

have, as shown in the other figures, where two pivoted points are used.

The fire-arm herein described is so simple in its general construction as not to require minute description of its operation. There are one or two movements of the details which it may be appropriate to refer to. In drawing back the hammer from its firing position to a half-cock, the mainspring receives all or about all the compression it gets. The mainspring is slacked up a little at the half-cock, when it pushes up the breech-block from a loading to a closed position; and it may recover this lost expansion as the hammer passes from the half to the full-cock, but it receives no more compression really at the full than it had at the half-cock.

The action of the mainspring upon the arms or levers *g j* is as follows: First, when the hammer is down the tendency of the mainspring is to engage the hook *f* with the hooks *c e*, and to keep the rolls *k* against the plane *b* on the breech-block projection. When the hammer is drawn back, the hooks being engaged, they cannot separate; but the drawing back of the hammer pulls down the breech-block, at the same time depressing the rolls *k*, and this forces down the levers or arms *j* against the mainspring, and, compressing said spring, its contact with the other arms or levers, *g*, is removed; but as the center of motion of the arms *j* is at *i*, and behind that *h* of the arms *g*, the force of the mainspring is exerted to raise up the rear ends of *g*, and consequently force down the forward or hooked end thereof, and, the moment that the breech-block rises far enough to allow the hook to pass the mainspring, will draw down the hook *f*, and then the hammer can be brought to the full-cock. When let go it immediately allows the hooks to re-engage. The ejector is swung away from the breech-block by the act of introducing the cartridge into the bore of the arm, and when the cartridge is in its chamber, the reaction of the mainspring through the lever or arms *j* throws up the breech-block into the closing position. By suddenly drawing back the hammer after the arm has been discharged, the breech-block is brought down, the empty cartridge-case thrown out, and the breech-block is held down by the ejector hooking over it. The cartridge may then be inserted and the mainspring throws up the breech-block; the hammer may then be brought to the full-cock, and the arm fired.

Having thus fully described my invention, what I claim therein as new, and desire to secure by Letters Patent, is—

1. The combination of a hammer and hook attached, and a breech-block hinged at its rear end, with a firing-pin passing through it, so that on pulling back the hammer to half-cock, the hook shall first draw back the firing-pin and then draw down the breech-block to a loading position, substantially as described.

2. In combination, the mainspring-lever, breech-block, and hook, whereby the double

purpose of raising the breech-block and of disengaging the hook therefrom is effected, substantially as described.

3. In combination with a breech-block hinged at its rear end and drawn down by the hammer, an ejector that catches and holds said breech-block, and that closes or bridges the space between said breech-block and the frame of the arm, and that is acted upon by the mainspring to bind it against said block and frame, substantially as described.

4. The combination of a breech-block hinged at its rear end with the hammer, lever, and mainspring, for the purpose of closing the breech and of operating the hammer, substantially as described.

5. The combination of the hammer, hooked lever, and mainspring, for the purpose of engaging and disengaging said hook from the breech-block, substantially as described.

6. The combination, herein shown and described, of a breech-block hinged at its rear end and an ejector near its front end, whereby said ejector hooks over and holds said breech-block when it is drawn down to a loading position, substantially as described.

7. The mechanism herein shown for drawing back the firing-pin by or through the medium of the hammer as it is raised, substantially as described.

8. The combination and relative arrangement of the hammer and mainspring, arranged for operation as described, whereby the mainspring is attached and moves with the hammer, substantially as described.

JAMES LEE.

Witnesses:

H. H. BENEDICT,
ISAAC OSGOOD.